

ДВИГАТЕЛИ ДЛЯ АГРОТЕХНИКИ СЕРИЙ 912/913

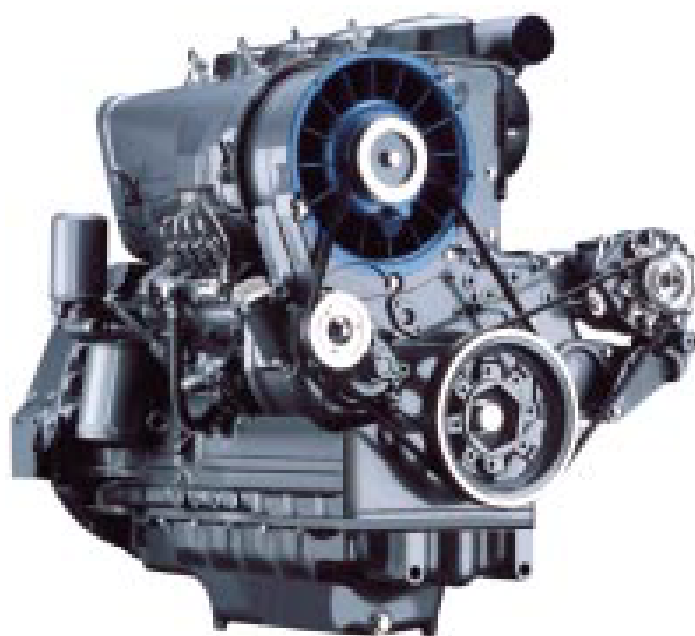

Архангельск (8182)63-90-72
Астана (7172)727-132
Астрахань (8512)99-46-04
Барнаул (3852)73-04-60
Белгород (4722)40-23-64
Брянск (4832)59-03-52
Владивосток (423)249-28-31
Волгоград (844)278-03-48
Вологда (8172)26-41-59
Воронеж (473)204-51-73
Екатеринбург (343)384-55-89
Иваново (4932)77-34-06

Ижевск (3412)26-03-58
Иркутск (395)279-98-46
Казань (843)206-01-48
Калининград (4012)72-03-81
Калуга (4842)92-23-67
Кемерово (3842)65-04-62
Киров (8332)68-02-04
Краснодар (861)203-40-90
Красноярск (391)204-63-61
Курск (4712)77-13-04
Липецк (4742)52-20-81

Магнитогорск (3519)55-03-13
Москва (495)268-04-70
Мурманск (8152)59-64-93
Набережные Челны (8552)20-53-41
Нижний Новгород (831)429-08-12
Новокузнецк (3843)20-46-81
Новосибирск (383)227-86-73
Омск (3812)21-46-40
Орел (4862)44-53-42
Оренбург (3532)37-68-04
Пенза (8412)22-31-16

Пермь (342)205-81-47
Ростов-на-Дону (863)308-18-15
Рязань (4912)46-61-64
Самара (846)206-03-16
Санкт-Петербург (812)309-46-40
Саратов (845)249-38-78
Севастополь (8692)22-31-93
Симферополь (3652)67-13-56
Смоленск (4812)29-41-54
Сочи (862)225-72-31
Ставрополь (8652)20-65-13

Сургут (3462)77-98-35
Тверь (4822)63-31-35
Томск (3822)98-41-53
Тула (4872)74-02-29
Тюмень (3452)66-21-18
Ульяновск (8422)24-23-59
Уфа (347)229-48-12
Хабаровск (4212)92-98-04
Челябинск (351)202-03-61
Череповец (8202)49-02-64
Ярославль (4852)69-52-93

Киргизия (996)312-96-26-47

Россия (495)268-04-70

Казахстан (772)734-952-31

<https://deutz.nt-rt.ru> || dze@nt-rt.ru



912/913. The engine for agricultural equipment.

32 - 128 kW at 2500 rpm

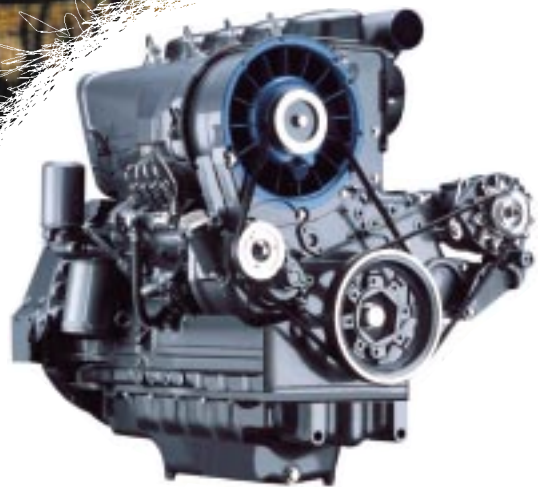

These are the characteristics of the 912 and 913:

- Air-cooled 3- to 6-cylinder naturally aspirated in-line engines.
- 4- and 6-cylinder 913 turbocharged, 6-cylinder also charge air cooled.
- Advanced direct injection and combustion system.
- Electronic governor on request.
- 100% PTO possibilities at flywheel and damper end.
- Auxiliary PTOs for hydraulic pumps and compressor possible.
- Enormous traction through high torque backup.
- Thanks to sophisticated modular system high degree of parts commonality.
- Extremely compact dimensions.

Your benefits:

- ▶ Noise-optimized technology reduces insulation requirements and increases driving comfort.
- ▶ Despite uprating high operating economy. Long service intervals, ease of service and low consumption values reduce operating costs.
- ▶ Space-saving design guarantees low installation space requirement. This in turn promotes the compactness of agricultural implements and enhances your competitive advantage in your markets.
- ▶ Logistic advantages and thus cost savings thanks to sophisticated modular system.
- ▶ All engines fulfill current exhaust emission standards. And they have the potential for meeting future exhaust emission standards via suitable provision for installation of advanced injection systems with no changes to installation envelope.

Engine description

Cooling system:	Air-cooled with integrated axial-flow blower
Crankcase:	Grey cast iron
Cylinder head:	Aluminium single cylinder heads
Valve arrangement/ timing:	Overhead valves in the cylinder head, one inlet and one exhaust valve per cylinder, actuated from gear-driven camshaft via tappets, push-rods and rocker arms
Piston:	Three-ring piston: two compression rings and one oil scraper ring
Piston cooling:	Oil spray via nozzle
Crankshaft:	Nodular cast iron with integrated counterweights
Connecting rod:	Drop-forged steel rod, diagonally split
Main and big end bearings:	Ready-to-install bi-metal plain bearings
Camshaft:	Steel, seated in bi-metal bearing on the blower side
Lubrication system:	Forced-feed circulation lubrication with rotary pump which feeds both lubricating and heating systems (if heating is fitted)
Engine oil cooler:	Integrated aluminium cooler
Oil cooler thermostat:	Oil cooler flow thermostatically controlled on engines with heating system
Lube oil filter:	Paper-type micro-filter as replaceable-cartridge full flow filter
Injection pump/ governor:	In-line injection pump with mechanical centrifugal governor
Injection nozzle:	Five-hole-nozzle
Fuel filter:	Replaceable cartridge
Starter motor:	12V; 2,7 kW (Standard)
Alternator:	Three-phase alternator, 14 V; 55A (Standard)
Heating system:	Optional connection for cab heating
Options:	Intake manifold connections, exhaust manifold connections, compressors, hydraulic pumps, engine mounts rigid and flexible, oil pans casted in self supporting design (3-, 4- and 6-cylinder engines), SAE 1/2/3/4 flywheel housings, three-phase alternators 12 and 24 Volt, integrated hydraulic oil cooler, cooling fans controlled by exhaust thermostat

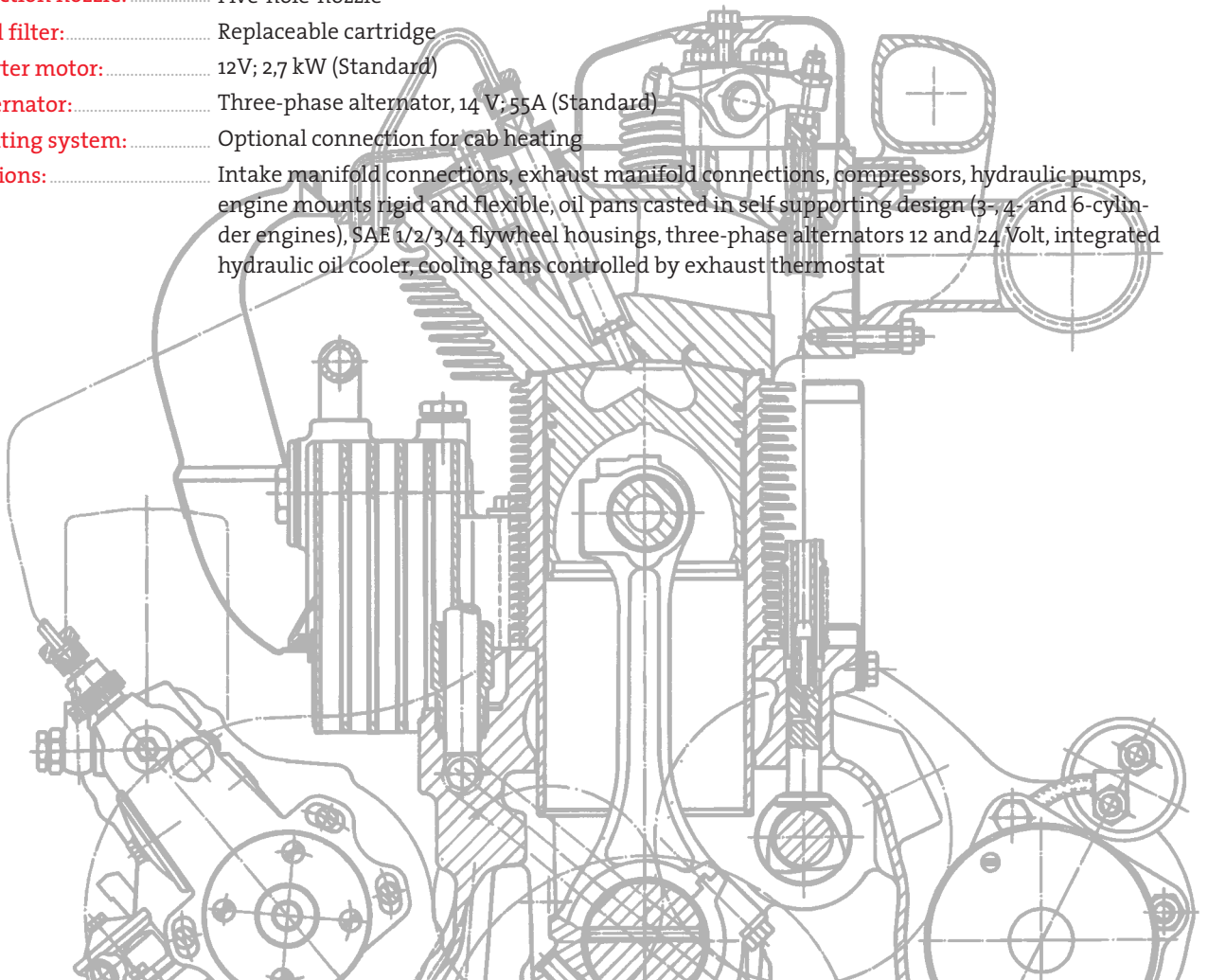

► Technical data

Engine type		F3L912	F4L912	F5L912	F6L912
Number of cylinders		3	4	5	6
Bore/stroke	mm	100/120	100/120	100/120	100/120
Displacement	l	2.827	3.770	4.712	5.660
Compression ratio		19	19	19	19
Max. rated speed	rpm	2500	2500	2500	2500
mean piston speed	m/s	10	10	10	10
Power ratings for agricultural application ¹⁾					
Power to ISO 3046/1 ²⁾	kW	38	51	65	70
at speed	rpm	2350	2350	2300	2300
mean effective pressure	bar	6.84	6.90	7.20	6.45
Max. torque	Nm	176	238	307	364
at speed	rpm	1450	1450	1450	1450
Minimum idle speed	rpm	650	650	650	650
Specific fuel consumption ³⁾	g/kWh	221	220	223	222
Weight to DIN 70020, part 7A ⁴⁾	kg	285	320	405	440

► Dimensions

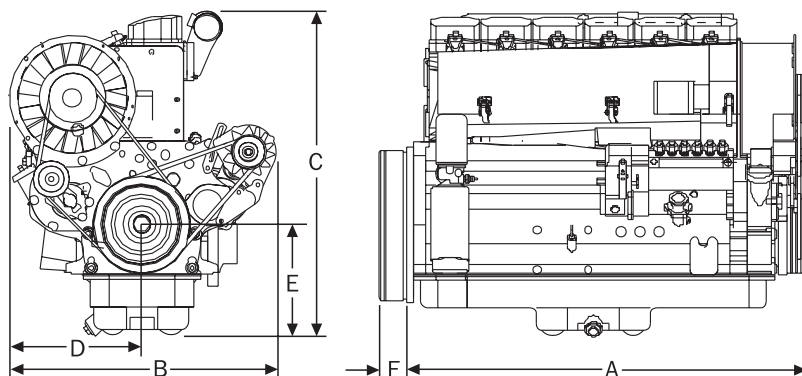

► Model designation

BF 6 L 913 C

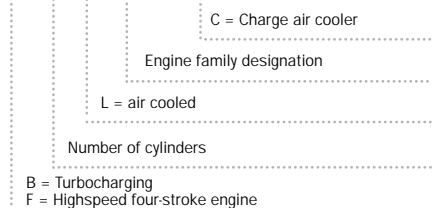

Engine		A	B	C	D	E	F
F3L912	mm	589	679	796	329	268	108
F4L912	mm	719	679	796	329	268	88
F5L912	mm	866	679	833	329	305	88
F6L912	mm	996	679	806	329	278	88

- 1) Power ratings without deduction fan power requirement, with integrated cooling system.
- 2) For specific engines (e.g. combine engines) higher customized power ratings possible.
- 3) At optimal operating point. Specific fuel consumption based on diesel fuel with a specific gravity of 0.835 kg/dm³ at 15° C.
- 4) Without starter motor/alternator, radiator and liquids, however with flywheel and flywheel housing and complete integrated cooling system.

Characteristics based on max. possible torque.

The values given in this data sheet are for information purposes only and not binding. The information given in the offer is decisive.

► Standard engines

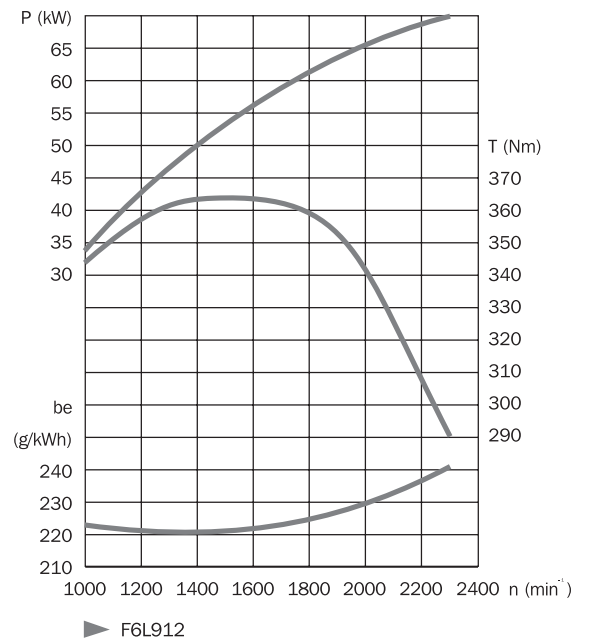
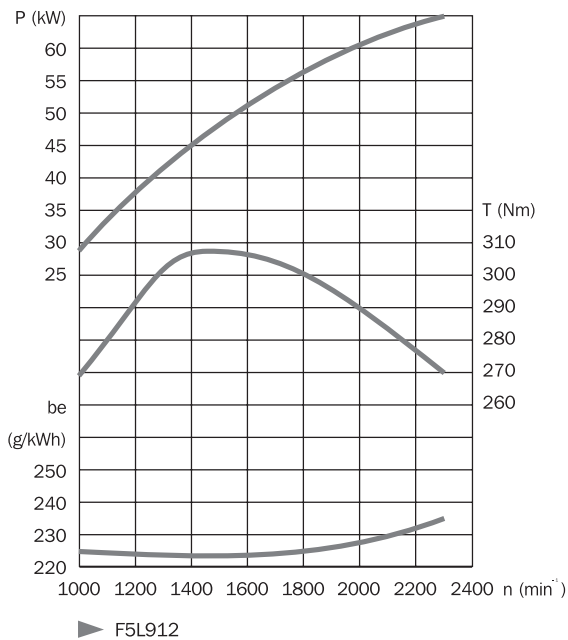
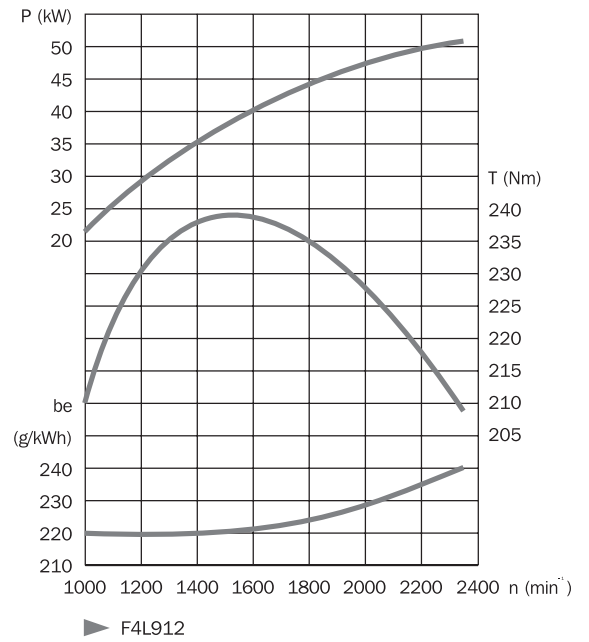
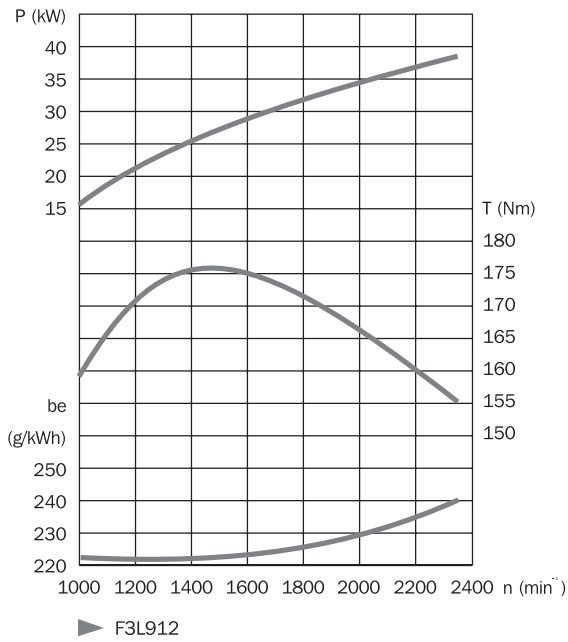

► Technical data

Engine type		F3L913	F4L913	BF4L913	F6L913	BF6L913	BF6L913C
Number of cylinders		3	4	4	6	6	6
Bore/stroke	mm	102/125	102/125	102/125	102/125	102/125	102/125
Displacement	l	3.064	4.086	4.086	6.128	6.128	6.128
Compression ratio		19	19	18	19	18	17
Max. rated speed	rpm	2500	2500	2500	2500	2500	2500
mean piston speed	m/s	10.4	10.4	10.4	10.4	10.4	10.4
Power ratings for agricultural applications ¹⁾							
Power ratings to ISO 3046/1 ²⁾	kW	44	56	65	76	95	128
at speed	rpm	2400	2350	2300	2300	2300	2300
mean effective pressure	bar	6.89	7.00	8.30	6.50	8.09	10.90
Max. torque	Nm	201	264	338	394	532	717
at speed	min ⁻¹	1450	1450	1600	1450	1600	1600
Minimum idle speed	min ⁻¹	650	650	650	650	650	650
Specific fuel consumption ³⁾	g/kWh	228	223	223	222	223	205
Weight to DIN 70020, part 7A ⁴⁾	kg	290	330	370	460	515	540

► Dimensions

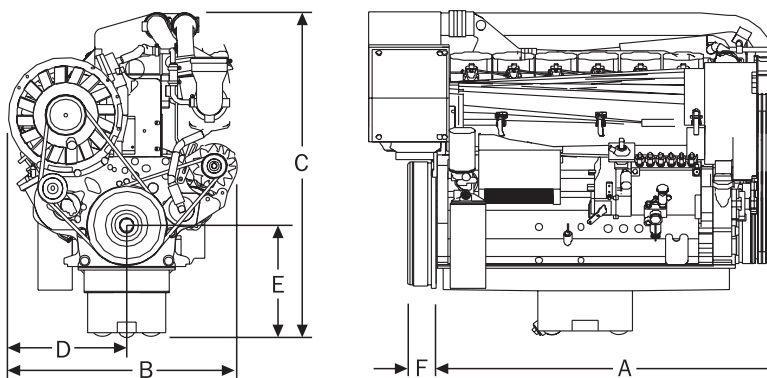

Engine		A	B	C	D	E	F
F3L913	mm	697	679	796	329	268	108
F4L913	mm	807	679	796	629	268	88
BF4L913	mm	814	692	853	341	268	88
F6L913	mm	1084	679	806	329	278	88
BF6L913	mm	1108	714	876	363	341	88
BF6L913C	mm	1137	714	876	363	341	88

- 1) Power ratings without deduction fan power requirement, with integrated cooling system.
- 2) For specific engines (e.g. combine engines) higher customized power ratings possible.
- 3) At optimal operating point. Specific fuel consumption based on diesel fuel with a specific gravity of 0.835 kg/dm³ at 15° C.
- 4) Without starter motor/alternator, radiator and liquids, however with flywheel and flywheel housing and complete integrated cooling system.

Characteristics based on max. possible torque.

The values given in this data sheet are for information purposes only and not binding. The information given in the offer is decisive.

► Standard engines

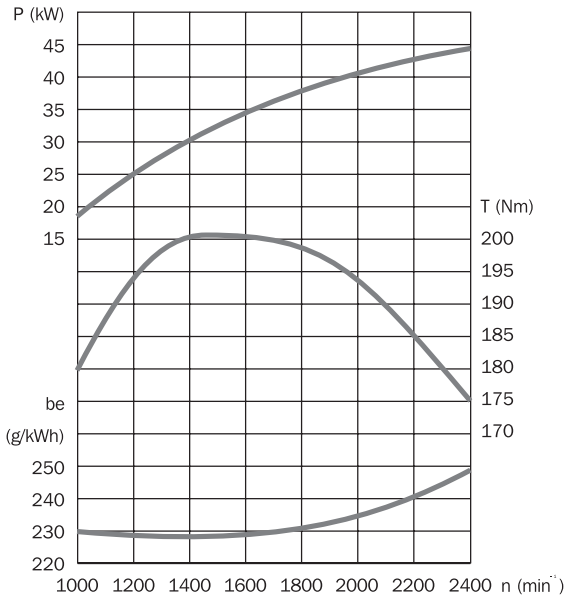

► F3L913

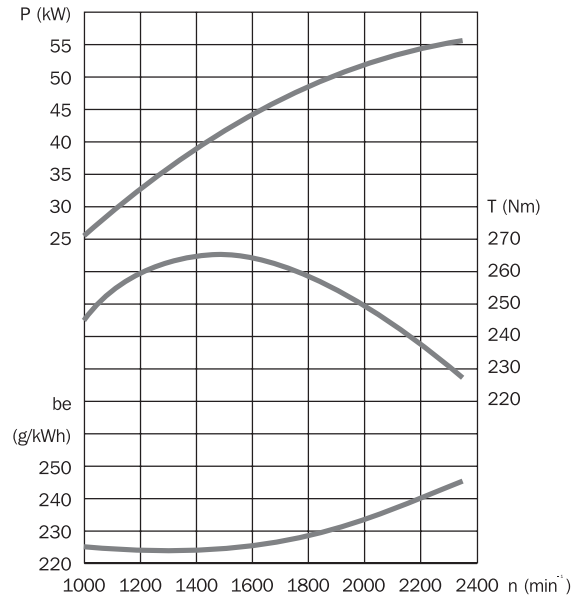

► F4L913

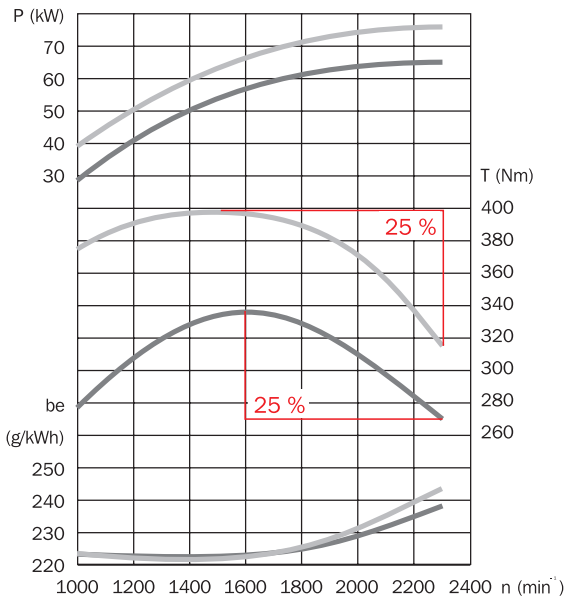

► BF4L913

► F6L913

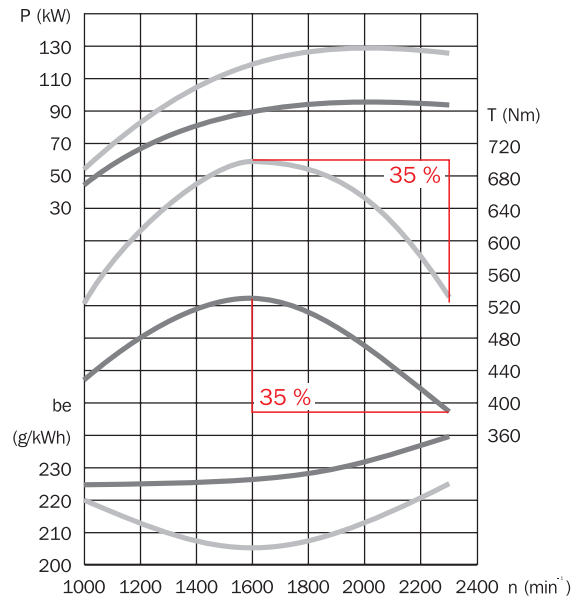

► BF6L913

► BF6L913C

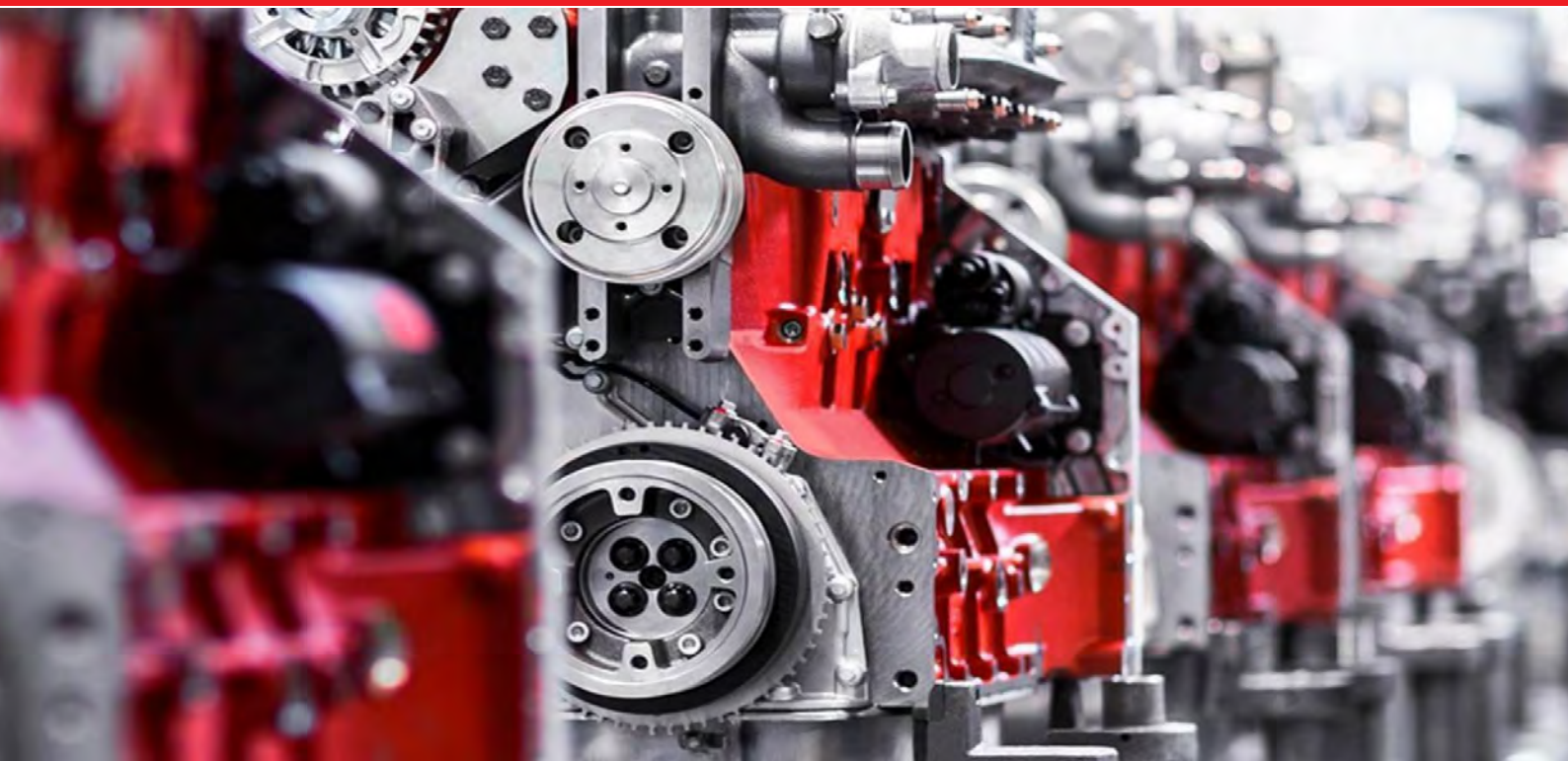

Архангельск (8182)63-90-72
Астана (7172)727-132
Астрахань (8512)99-46-04
Барнаул (3852)73-04-60
Белгород (4722)40-23-64
Брянск (4832)59-03-52
Владивосток (423)249-28-31
Волгоград (844)278-03-48
Вологда (8172)26-41-59
Воронеж (473)204-51-73
Екатеринбург (343)384-55-89
Иваново (4932)77-34-06

Ижевск (3412)26-03-58
Иркутск (395)279-98-46
Казань (843)206-01-48
Калининград (4012)72-03-81
Калуга (4842)92-23-67
Кемерово (3842)65-04-62
Киров (8332)68-02-04
Краснодар (861)203-40-90
Красноярск (391)204-63-61
Курск (4712)77-13-04
Липецк (4742)52-20-81

Магнитогорск (3519)55-03-13
Москва (495)268-04-70
Мурманск (8152)59-64-93
Набережные Челны (8552)20-53-41
Нижний Новгород (831)429-08-12
Новокузнецк (3843)20-46-81
Новосибирск (383)227-86-73
Омск (3812)21-46-40
Орел (4862)44-53-42
Оренбург (3532)37-68-04
Пенза (8412)22-31-16

Пермь (342)205-81-47
Ростов-на-Дону (863)308-18-15
Рязань (4912)46-61-64
Самара (846)206-03-16
Санкт-Петербург (812)309-46-40
Саратов (845)249-38-78
Севастополь (8692)22-31-93
Симферополь (3652)67-13-56
Смоленск (4812)29-41-54
Сочи (862)225-72-31
Ставрополь (8652)20-65-13

Сургут (3462)77-98-35
Тверь (4822)63-31-35
Томск (3822)98-41-53
Тула (4872)74-02-29
Тюмень (3452)66-21-18
Ульяновск (8422)24-23-59
Уфа (347)229-48-12
Хабаровск (4212)92-98-04
Челябинск (351)202-03-61
Череповец (8202)49-02-64
Ярославль (4852)69-52-93

Киргизия (996)312-96-26-47

Россия (495)268-04-70

Казахстан (772)734-952-31

<https://deutz.nt-rt.ru> || dze@nt-rt.ru